



NEW PURIFIERS AND SANITISERS



VORTICE S.p.A. is part of a multinational group, **VORTICE GROUP**, which operates through its own companies or local distributors in over 90 countries worldwide and has a rich product portfolio that guarantees air quality and climate comfort. The headquarters of VORTICE S.p.A are in Tribiano (Milan).



VORTICE GROUP also includes:

[1]
VORTICE LIMITED, the UK subsidiary of VORTICE S.p.A., established in 1977 and based in Burton on Trent.

[2]
VORTICE INDUSTRIAL, born from the acquisition in 2010 of Loran srl, based in Isola della Scala (VR).

[3]
VORTICE VENTILATION SYSTEM, a company inaugurated in 2013 with headquarters in Changzhou, China.

[4]
VORTICE LATAM S.A., based in Alajuela in Costa Rica, established in 2012.

[5]
CASALS VENTILACIÓN AIR INDUSTRIAL S.L., historic Spanish brand, based in Sant Joan de les Abadesses, Girona, acquired in 2019.

INDEX

p 06

HOW THE FILTERING AND SANITISING SYSTEM WORKS

p 10

DEPURO PLUS & DEPURO PLUS EVO

Portable air purifiers and sanitisers for commercial and industrial applications.

p 24

DEPURO SKY & DEPURO SKY EVO

High efficiency air purifiers and sanitisers for ceiling and concealed installation and for commercial and industrial applications.

Regulatory standards

The products of the DEPURO PLUS and DEPURO SKY Series are compliant with the following Directives and Standards in their most recent versions:

-
- Machinery Directive: 2006/42/EC;
 - Electromagnetic Compatibility Directive: 2004/108/EC; 2014/30/EC;
 - RoHS Directive: 2011/65/EU;
 - WEEE Directive: 2012/19/EU;
 - ECODESIGN Directive 2009/125/EC for fans according to ERP Regulation No. 327/2011/EU
 - Electrical Safety Regulations: EN 60204-1; EN 12000; EN 13857; EN 60335-1; EN 60335-2-65; EN 60529; EN 62233;
 - Electromagnetic Compatibility Emission Standard: EN 55014-1; EN 55014-2; EN 61000-3-2; EN 61000-3-3.



PURIFIED
AIR



FILTERED
AIR



SANITISATION



LOW
CONSUMPTION



GREAT
ROBUSTNESS

AIR PURIFIERS AND SANITISERS

The quality of indoor air has never been as crucial for a healthy life and for the people's well-being as it is today. Air quality technologies represent essential solutions to reduce the risk of the spread of pathogens such as viruses, bacteria and moulds, but also dust, mites, seasonal pollen and fine dust.

In order to improve the air quality, it is fundamental to focus on air exchange, purification and sanitisation. Combining these three processes, it is possible to act on the pathogens, so to neutralise them and consequently to ensure the health and safety of the people in the rooms.



FILTERING AND SANITISING SYSTEM*

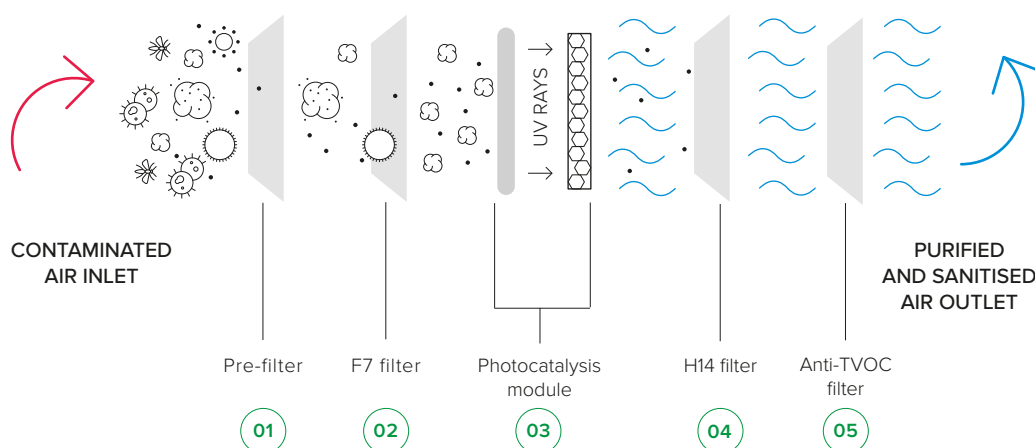

6

01 Pre-filters

Washable pre-filters for all products of the DEPURO PLUS series and ISO Coarse 65% (G4) class pre-filters for all products of the DEPURO SKY series.

Pre-filters and ISO ePM1 (F7) filters are installed in correspondence of the intake spigots on all products, and are able to retain the macro impurities of the air, protecting the filters behind them and thus extending their life.

02 ISO ePM1 (F7) filters

ISO ePM1 60% (F7) filters for all products of the DEPURO PLUS series and ISO ePM1 70% filters for all products of the DEPURO SKY (F7) series.

04 HEPA H14 filters

HEPA H14 absolute filters, capable of retaining up to 99.995% of microparticles (equivalent diameter $\leq 0.3\mu\text{m}$).

HEPA filters are highly effective and guarantee the control of coarse, fine and ultra-fine dust particles, allergens and microorganisms.

05 Anti-TVOC (Total Volatile Organic Compounds) filter (DEPURO PLUS RANGE)

The anti-TVOC filter is placed near the treated air outlet grille, after the HEPA filter, with the task to retain bad odour, aldehydes, ozone and volatile organic compounds.

** The sanitisation module is installed ONLY on EVO models belonging to the DEPURO PLUS and DEPURO SKY series.*

Certification of the effectiveness of the HEPA H14 filter*

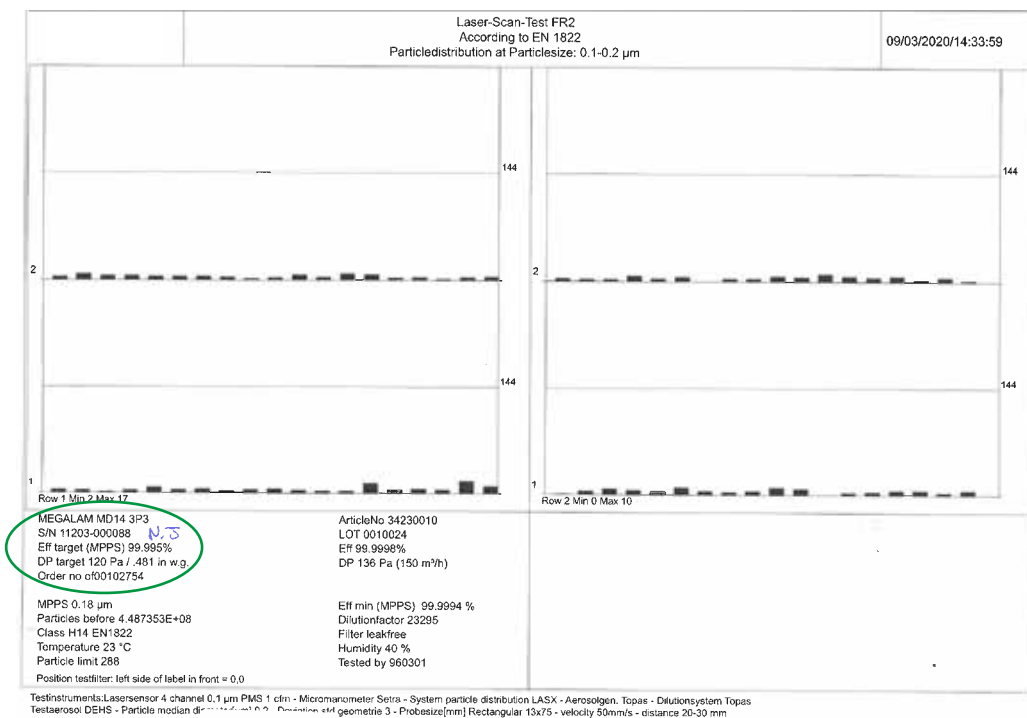

* Examples of certification of one of our filters supplier.

Filter maintenance

Filters are easily replaceable thanks to the quick release of the panels.

The actual need for periodic replacement of the filters is indicated on the control panel on the machine.

The duration of the filters in a purifier depends on three factors: the hours of use, the flow of treated air (in turn according to the rotation speed of the fan) and the concentration of pollutants in the room.

All this being said, in general it is possible to replace the G4 and F7 filters on average every 4/6 months in the presence of relatively clean air (offices and commercial buildings in general), or every 2/4 months if the treated air is charged with pollutants (e.g. warehouses, workshops, etc.). These intervals increase respectively to 10/12 months, or 8/10 months, for the HEPA H14 absolute filters.

ATTENTION. Given the high retention capacity of polluting agents dangerous for health, such as pollens, spores and microorganisms (bacteria and viruses), when replacing the filters it is recommended to use appropriate individual protective equipment (mask, gloves, glasses) designed to prevent inhalation and, more generally, direct contact.

AN EFFECTIVE TECHNOLOGY AGAINST COVID-19

03 Photocatalysis module (EVO models only)

The photocatalysis unit used is based on the photocatalytic oxidation process (used in hospitals and in the aerospace, medical and food industries), which is a natural phenomenon that occurs in the presence of ultraviolet rays from the sun, air humidity and some noble metals. The combination of these three factors triggers the release of oxidising ions capable of neutralising the majority of pathogens in the air, which are potentially dangerous to our health.



The DEPURO PLUS EVO and DEPURO SKY EVO ultraviolet (UV) lamp illuminates a catalyst made from a special alloy based on titanium dioxide (TiO_2), which causes a photochemical reaction where oxygen (O) atoms bind with molecules of water (H_2O) dissolved in the air in the form of vapour.

The hydrogen peroxide molecules (H_2O_2) generated from this reaction are sufficient to eliminate most of the bad odours, moulds, bacteria, viruses and allergens present both in the air and on the surfaces, **SANITISING THEM**.

The estimated service life of the UV lamp is two years.

How a photocatalytic system works*

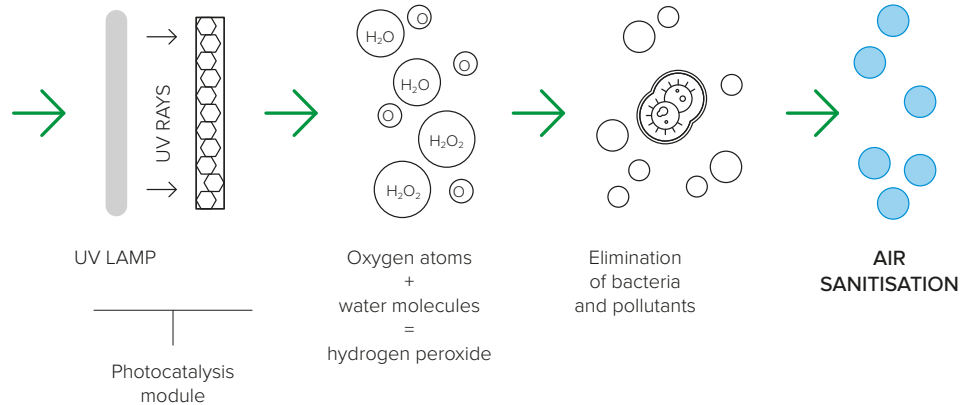

*Diagram of a generic photocatalysis process (by way of an example).

The irradiation of the catalyst through an ultraviolet light with an adequate wavelength activates the release of OH free radicals whose action, strongly oxidising, is the basis of the sanitisation process: atmospheric pollutants such as carbon dioxide (CO_2), sulphur oxides (SO_x), nitrogen oxides (NO_x), carbon monoxide (CO) and polycyclic aromatic hydrocarbons (PAHs) are transformed into compounds characterised by levels of heavily reduced toxicity, as in the case of nitrogen monoxide (NO) and nitrogen dioxide (NO_2), which are both converted into NO_3 .

Similarly, VOCs, a category of compounds to which, among others, formaldehyde and acetone belong, are among the primary causes of bad odours in enclosed environments: they are decomposed and transformed into harmless substances, such as CO_2 and water.

In case of pathogenic microorganisms such as bacteria and viruses, the impact of the oxidising action damages their outer protective coating, which causes their death.



RIASSUNTO CONCLUSIVO

DICHIARAZIONE EFFICACIA TECNOLOGIA DUST FREE



Dalla sperimentazione condotta all'interno del Dipartimento di Scienze biomediche e cliniche "Luigi Sacco" si evince che la tecnologia Dust-Free FC UNIT 3" ha mostrato capacità di abbattere la carica virale di SARS-CoV-2 inoculata in fase liquida sia su una superficie che su un tessuto.

L'abbattimento verificato sul petri inoculato di SARS-CoV-2, esposto all'aria trattata per 20 minuti in un volume di 2,13 m³, ha mostrato una riduzione di 1.0 log (90.0%) maggiore rispetto al decadimento naturale del virus verificato nella prova di controllo, eseguita a pari condizioni, ma senza tecnologia Dust Free.

L'abbattimento verificato sul panno costituito per il 45% in polietere e 55% cellulosa, inoculato di SARS-CoV-2, esposto all'aria trattata per 20 minuti in un volume di 2,13 m³, ha mostrato invece una riduzione di 2.5 log (99.7%) maggiore rispetto al decadimento naturale del virus verificato nella prova di controllo, eseguita a pari condizioni, ma senza tecnologia Dust Free.

Il ventilatore impiegato ha portata d'aria pari a 35 mch.

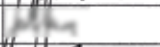
PROTOCOLLO DI VALUTAZIONE DELL'ATTIVITA' VIRUCIDA DEL DISPOSITIVO NEVOLA SU SARS-CoV-2

	NOME	FUNZIONE	FIRMA	DATA
Redatto da	David Piatto	Principal Investigator		09/11/2020
Revisionato da	Luca Gatti	Committente (Air-Control Srl)		09/11/2020
	Luca Tabetelli	Produttore Nevola (Kemin Textile Srl)		09/11/2020
Approvato da	Maria Rita Giromondo	Supervisore		9/11/2020

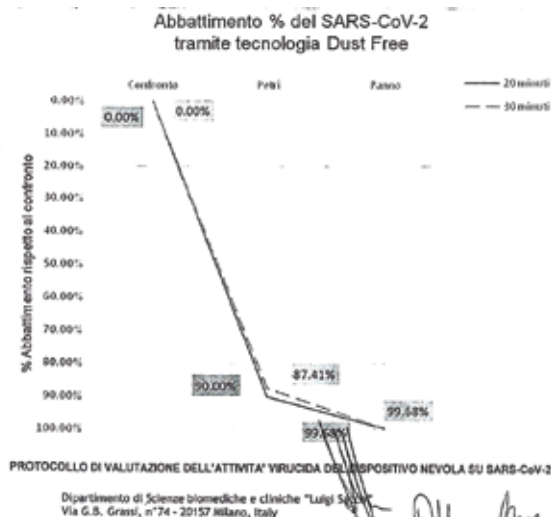

DECLARATION EFFECTIVENESS "DUST FREE TECHNOLOGY "

From the experimentation conducted within the Department of Biomedical and Clinical Sciences "Luigi Sacco" it is clear that the Dust-Free FC UNIT 3" technology has shown the ability to break down the viral load of SARS-CoV-2 inoculated in liquid phase both on a surface and on a tissue. The abatement verified on the inoculated petri dish of SARS-CoV-2, exposed to treated air for 20 minutes in a volume of 2.13 m³, showed a reduction of 1.0 log (90.0%) greater than the natural decay of the virus verified in the control test, performed under equal conditions, but without Dust Free technology. The abatement verified on the cloth consisting of 45% polyether and 55% cellulose, inoculated with SARS-CoV-2, exposed to the treated air for 20 minutes in a volume of 2.13 m³, showed a reduction of 2.5 log (99.7%) greater than the natural decay of the virus verified in the control test, performed under the same conditions, but without Dust Free technology. The fan used has an air flow rate of 35 mch.

DEPURO PLUS

DEPURO PLUS EVO

Portable air purifiers and sanitisers for commercial and industrial use.

Range of air purifiers specifically designed for commercial and industrial applications (shops, offices, beauty centres, hair salons, dental offices, post offices, waiting rooms, warehouses, etc.) with a surface area up to approximately 160m². They are at the top of their category thanks to their low sound emission and very high filtering capacity, featuring multistage system which includes an absolute HEPA H14 filter, fully compliant with the requirements of the EN1822 standard and capable of retaining 99.995% of particles with dimensions $\leq 0.3\mu\text{m}$. The EVO versions combine mechanical filters with a photocatalysis module, used to sanitise the treated air flow.



USE

The DEPURO PLUS purifiers are particularly suitable for the purification, while the DEPURO PLUS EVO are also ideal for the sanitisation of the air in domestic, commercial and industrial environments with a surface up to 160m².

As an example, some of the places where they can be used are analysis laboratories, medical and dental offices, offices, meeting rooms, bars, restaurants, gyms, fitness centres, beauty centres and hair salons, shops, professional offices, pharmacies, RC, schools and kindergartens, warehouses and logistics centres, workshops, etc.



BENEFITS FOR THE USER

DEPURO PLUS
effective against viruses and bacteria

DEPURO PLUS EVO
also effective against COVID-19

01

Effectiveness against microorganisms,

thanks to the very high filtering capacity of the pair of HEPA H14 absolute filters, capable of retaining up to 99.995% of microparticles (equivalent diameter 0.3µm).

02

Effective sanitising action

of the EVO models, thanks to their photocatalysis module, against fungi, bacteria and viruses, and also against the SARS-CoV2 virus responsible for the COVID-19 pandemic, as proven by the tests performed at the Biomedical and Clinical Sciences Department “Luigi Sacco” of the University of the Studies of Milan.

03

Reduced consumption,

thanks to the high efficiency fans driven by EC motors (brushless).

04

High-level performances

05

Low noise emissions,

perfectly compatible with the use in work environments (offices, firms, etc.).

06

Easily transportable,

thanks to the handle and the 4 wheels equipped with a blocking device for a greater safety of use.

07

Great robustness,

as a result of the design and construction solutions adopted, starting from the casing, which boasts excellent resistance to impact and corrosion.

08 Simple and intuitive management:

the integrated control panel makes the operation modes setting and filter replacement very easy.

09 Easy installation:

just insert the plug into the electrical outlet. **Plug and Play.**

10 Easy maintenance.

The need to replace the filters is signalled by the control panel. Moreover, filters and photocatalysis module are easily replaceable, thanks to the quick release of the panels.



APPLICATIONS

14





TECHNICAL CHARACTERISTICS

Available models

- 4 models available, with two sizes and the photocatalysis module (only in the EVO models).
- **DEPURO PLUS 230 (code 26061) and DEPURO PLUS EVO 230 (code 26062)** having a maximum flow rate of 460 m³/h for environments up to 85m².
- **DEPURO PLUS 430 (code 26063) and DEPURO PLUS EVO 430 (code 26064)** having a maximum flow rate of 860 m³/h for environments up to 160m².

Casing

- Steel bearing structure; external sandwich panel coating (thickness 20mm) with holes on the internal side, thermally and acoustically insulated with melamine (density 11 kg/m³), self-extinguishing (class V0 according to the UL94 standard).
- A synthetic rubber gasket, installed in correspondence of the upper edge of the device, that protects against the risk of damage to people and property resulting from accidental contact.
- Side air intake grilles positioned at a height that maximizes the air treatment.
- Purified air delivery at the upper surface of the product.

Fans

- Centrifugal motor fans with forward blades and auger, double intake, powered by EC brushless permanent magnet motors (the same technology used in the most recent electric cars), speed-adjustable with 0-10V signal.

Photocatalysis (EVO models)

- **The technology of the DUST FREE modules** uses the combined action of the rays of a special **UV lamp** with a catalyst structure built from a metal alloy with honeycomb matrix, mainly composed of **TiO₂ (titanium dioxide)** and, to a minor extent, of other noble metals.

Filters

- **Four-stage filtering system** composed of:
 - **2 washable pre-filters;**
 - **2 ePM1 60% (F7) filters;**
 - **1 HEPA H14 class absolute filter, of the planar type for models 230, and multiple dihedral on models 430;**
 - **1 anti-TVOC (Total Volatile Organic Compounds) filter.**
- The pre-filters and the intermediate filter, placed in correspondence of the intake spigots, retain the macro impurities and the particulate in the air, protecting the absolute filter installed above them, which has the task of destroying almost all of the finest microparticulate (99.995% of the micro-dust with nominal dimensions equal to or below 0.3µm), extending their useful life.
- The anti-TVOC filter, placed downstream of the absolute filter, retains bad odour, aldehydes, ozone and volatile organic compounds.
- The actual need for periodic replacement of the filters is indicated on the control panel on the machine.

Control panel

- Control panel, located at one of the side walls of the product, for:
 - switching on/off;
 - activating/deactivating the photocatalysis module (in EVO models);
 - programming, on a daily basis, the operation of the product, which will automatically switch on/off at the previously set hours;
 - programming, in three time bands, the fan speed so that the ideal compromise between efficient purification, noise emissions and consumption can be reached;
 - programming on a daily basis of the switching on/off of the UV lamp, which activates the photocatalysis process (in EVO models);
 - setting the operating mode: Manual (switching on and off are left to the user) or Automatic (time programming previously set);
 - 10-step adjustment of the treated air flow;
 - indication, distinguished by type, of the occurred saturation of the filters and the consequent need for their replacement.



1 HEPA H14 FILTER,
capable of retaining up to
99.995% of microparticles
(equivalent diameter
 $\leq 0.3\mu\text{m}$).



Low
consumption.



Equipped with
Brushless motors.



Quiet operation, guaranteed by
sound-absorbing sandwich panels.



Control
panel.

Optional table for
both models.

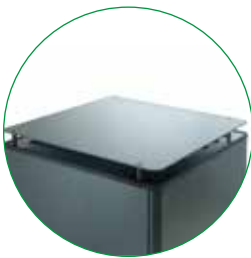

On the rear part, panels
with quick release closure
devices, providing easy
access to the filters.



Photocatalysis
module in the
EVO models
only.



Power cable 3 metres long
with Schuko plug.



Plug&Play.



Easily transportable, thanks
to the handle and 4 wheels
for easier movement of the
product.



DEPURO PLUS & DEPURO PLUS EVO
PORTABLE AIR PURIFIERS AND SANITISERS
FOR COMMERCIAL AND INDUSTRIAL APPLICATIONS





DEPURO PLUS & DEPURO PLUS EVO
 PORTABLE AIR PURIFIERS AND SANITISERS
 FOR COMMERCIAL AND INDUSTRIAL APPLICATIONS

Technical data

PRODUCT	CODE	V~50/60Hz	W max	A max	MAX FLOW RATE (m ³ /h)	SURFACES UP TO (m ²)	Lp dB (A) 6m	TEMP. °C min/max	WEIGHT Kg
DEPURO PLUS 230	26061	220-240	115	0,90	460	85	41,2	-10/40	40
DEPURO PLUS EVO 230	26062								
DEPURO PLUS 430	26063	220-240	225	1,70	860	160	46,7	-10/40	45
DEPURO PLUS EVO 430	26064								

Dimensions

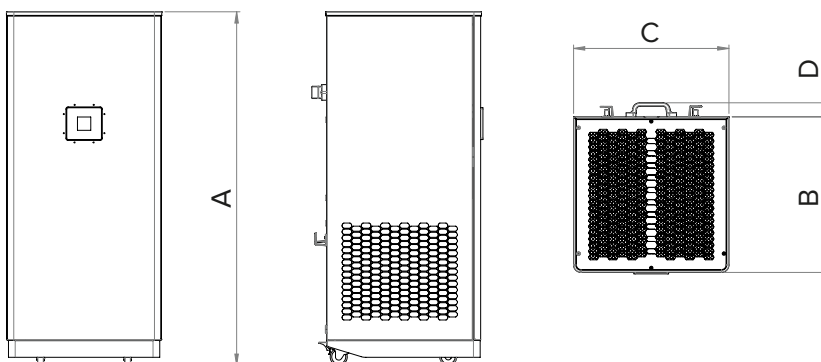





20

PRODUCT	A	B	C	D
DEPURO PLUS 230	862	457	457	41
DEPURO PLUS EVO 230				
DEPURO PLUS 430	1039	457	457	41
DEPURO PLUS EVO 430				

Dimensions in mm

Replacement filters

	DESCRIPTION	CODE	PRODUCT	
	2Pre-FTR 340x290x20 Pair of Pre-filters. Dimensions: 340 x 290 x 20	13138	26061 26062 26063 26064	
	2FTR-ePM1 60% (F7) 300x400x23 Pair of ISO Coarse 60% (F7) class filters. Dimensions: 300 x 400 x 23		13139	26061 26062 26063 26064
	FTR-H14 400x400x115 H14 class absolute filter. Dimensions: 400 x 400 x 115			13140
	FTR-H14 400x400x292 H14 class absolute filter. Dimensions: 400 x 400 x 292		13141	
	FTR-TVOCS 386x376x7 Anti-TVOC filter. Dimensions: 386 x 376 x 7	13142	26061 26062 26063 26064	

EXPLODED VIEW OF THE FILTERING AND SANITISING SYSTEM*

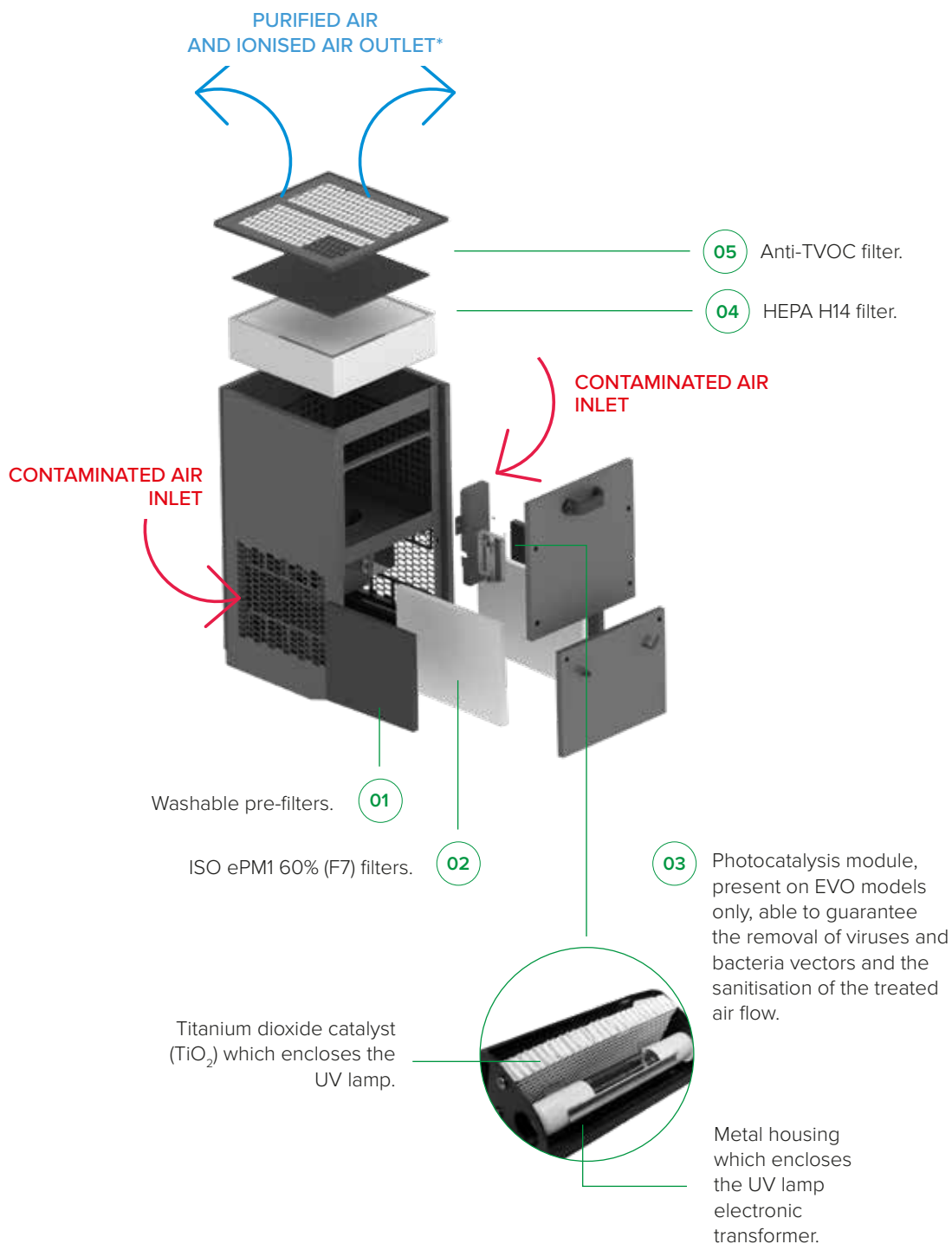

* The sanitisation module is installed on EVO models ONLY.

DEPURO PLUS & DEPURO PLUS EVO
PORTABLE AIR PURIFIERS AND SANITISERS
FOR COMMERCIAL AND INDUSTRIAL APPLICATIONS

22





DEPURO SKY & DEPURO SKY EVO

HIGH EFFICIENCY INSTALLATION AIR PURIFIERS AND SANITISERS
FOR CEILING AND CONCEALED INSTALLATION AND FOR COMMERCIAL AND INDUSTRIAL APPLICATIONS

DEPURO SKY

DEPURO SKY EVO



Installation air purifiers and sanitisers for commercial and industrial applications.

DEPURO SKY is a range of high efficiency air purifiers which are powerful, easy to install and service, and quiet, thanks to the soundproof panels.

The DEPURO SKY air purifiers are able, thanks to the high dimensions of the filtering system, to quickly remove any concentrations of pollutants, allergens and pathogens present in the air, ensuring the safety and comfort of the occupants.



USE

DEPURO SKY are particularly suitable for purification and **DEPURO SKY EVO** also for air sanitation in commercial or industrial environments with a surface area of up to 330m².

Some examples of the places where it is possible to use them are: public buildings, meeting places and workplaces such as supermarkets, exhibition halls, gyms, restaurants, hotels, schools, universities, clinics and hospitals, offices, etc.



BENEFITS FOR THE INSTALLER

DEPURO SKY
effective against viruses and bacteria

DEPURO SKY EVO
also effective against COVID-19

01

Wide range of possible applications

thanks to the possibility of false ceiling installation with ducted distribution for the DEPURO SKY models (e.g. to meet the needs of separate premises), or directly on the ceiling for the DEPURO SKY EASY models in case of a single environment.

02

Easy maintenance,

thanks to the panels with quick release closure devices, providing easy access to the filters and UV lamp (in EVO models). The need to replace the filters is signaled by the control panel.

BENEFITS FOR THE USER

01

High filtering capacity

the HEPA H14 absolute filters are able to retain pollutants such as pollen, spores, droplets and microparticles, potential vectors of viruses and bacteria, thus significantly limiting the risk of contracting allergies, asthma, respiratory problems and infections.

02

Effective sanitising action

of the EVO models, thanks to their photocatalysis module, against fungi, bacteria and viruses, including the SARS-CoV2 virus responsible for the COVID-19 pandemic, **as proven by the tests performed at the Biomedical and Clinical Sciences Department “Luigi Sacco” of the University of the Studies of Milan.**

03 **Reduced consumption**

thanks to the high efficiency fans driven by **EC motors** (brushless).

04 **Simple and intuitive management**

the control panel with wired connection makes the operation modes setting and filter replacement very easy.

05 **Great robustness,**

as a result of the design and construction solutions adopted, typical of the industrial sector, starting from the casing, which boasts excellent resistance to impact and corrosion.



DEPURO SKY & DEPURO SKY EVO

HIGH EFFICIENCY INSTALLATION AIR PURIFIERS AND SANITISERS
FOR CEILING AND CONCEALED INSTALLATION AND FOR COMMERCIAL AND INDUSTRIAL APPLICATIONS

APPLICATIONS



28





TECHNICAL CHARACTERISTICS

Available models

- 4 models available, differing for dimension, performances, installation type and for the presence, in the EVO models, of the photocatalysis module.
 - **DEPURO SKY (code 25091)** and **DEPURO SKY EVO (code 25092)** having a maximum flow rate of 1,800 m³/h for environments up to 330m².
 - **DEPURO SKY EASY (code 25093)** and **DEPURO SKY EASY EVO (code 25094)** having a maximum flow rate of 1,200 m³/h for environments up to 265m².
- Note: In the case of environments with an height of 3 metres, considering 2 complete filtrations of the environmental air per hour.*

Casing

- Housings with bearing structure made with extruded aluminium profiles, 30mm thick, with nylon corner joints.
- 25mm thick sandwich panels in pre-painted steel sheet, light gray, RAL 9006, class M0, with anti-corrosion finish, acoustically insulated with fire-resistant rock wool (class A1), density 90 kg/m³.
- Rectangular air intake and delivery ports complete with protection grilles which can be oriented manually (DEPURO SKY EASY EVO model).

Fans

- **High efficiency fan motors**, whose speed can be adjusted using the control panel supplied with the device, consisting of single-phase EC (brushless) motors of the external rotor type, characterised by a IP44-grade protection and class B insulation, directly coupled to a centrifugal, self-cleaning impellers with reversed blades, moulded in polyamide, statically and dynamically balanced at the factory.

Photocatalysis (EVO models)

- **The technology of the DUST FREE modules** uses the combined action of the rays of a special **UV lamp** with a catalyst structure built from a metal alloy with honeycomb matrix, mainly composed of **TiO₂ (titanium dioxide)** and, to a minor extent, of other noble metals.

Filters

- **3-stage filtering devices**, optimised to retain impurities of progressively decreasing dimension, so to guarantee a very high overall filtering capacity of the treated air, at the same time preventing the untimely clogging of the superior class filters; the actual need for periodical filters replacement interventions is signaled on the control panel of which each machine of this range is provided.
- **The DEPURO SKY EVO model is equipped with 15 filters:** 5 ISO Coarse 65% (G4) pre-filters; 5 ISO ePM1 70% (F7) filters; 5 HEPA H-14 filters.
- **The DEPURO SKY EASY EVO model is equipped with 6 filters:** 1 ISO Coarse 65% (G4) pre-filter; 1 ISO ePM1 70% (F7) filter; 4 HEPA H-14 filters.

Control panel

- Wire-connected control panel with LCD display for:
 - switching on/off;
 - activating/deactivating the photocatalysis module (in EVO models);
 - programming, on a daily basis, the operation of the product, which will automatically switch on/off at the previously set hours;
 - programming, in three time bands, the fan speed so that the ideal compromise between efficient purification, noise emissions and consumption can be reached;
 - programming on a daily basis of the switching on/off of the UV lamp, which activates the photocatalysis process (in EVO models);
 - setting the operating mode: Manual (switching on and off are left to the user) or Automatic (time programming previously set);
 - adjustment of the treated air flow;
 - indication, distinguished by type, of the occurred saturation of the filters, and the consequent need for their replacement;
 - connection to a Building Management System (BMS), Modbus RS485 protocol, for the simultaneous control of up to 32 devices.

6 FILTERS

The DEPURO SKY EASY models are equipped with 6 filters:
1 ISO Coarse 65% (G4) pre-filter;
1 ISO ePM1 70% (F7) filter;
4 HEPA H-14 filters.

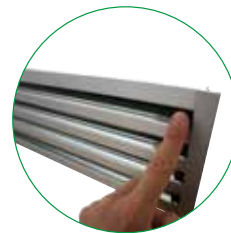

The 4 delivery sections are equipped with a diffuser which can be manually oriented upon installation.



Photocatalysis module in the EVO models only.



Equipped with Brushless motors.



Low consumption.



Control panel, standard on both models.



Quiet operation, compatible with the use in commercial and industrial environments, guaranteed by the sandwich sound-absorbing panels.

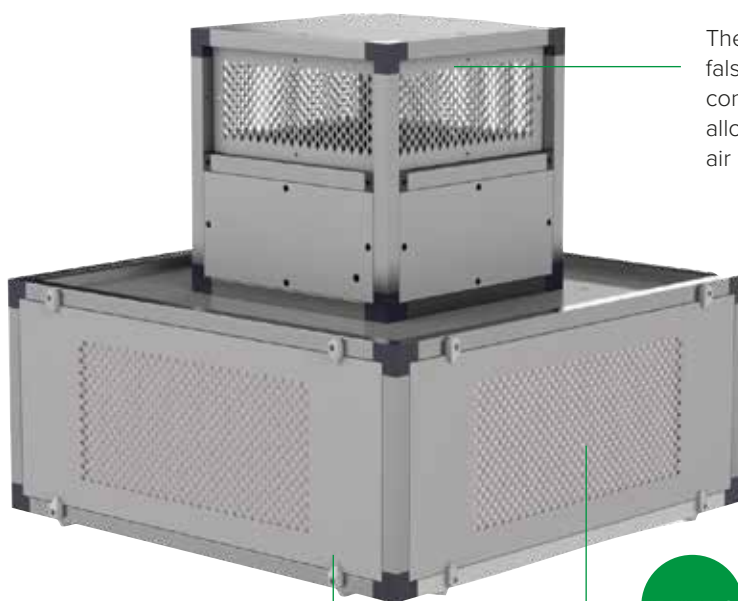

The rectangular ports hidden in the false ceiling are compatible with the connection with rectangular piping, allowing for the introduction of purified air in the premises.

15 FILTERS

The DEPURO SKY models are equipped with 15 filters:
5 ISO Coarse 65% (G4) pre-filters;
5 ISO ePM1 70% (F7) filters;
5 HEPA H-14 filters.

Panels with quick release closure device, providing easy access to the filters.

DEPURO SKY & DEPURO SKY EVO

HIGH EFFICIENCY INSTALLATION AIR PURIFIERS AND SANITISERS
FOR CEILING AND CONCEALED INSTALLATION AND FOR COMMERCIAL AND INDUSTRIAL APPLICATIONS

Technical data

PRODUCT	CODE	V~50/60Hz	W max	A max	RPM max	MAX FLOW RATE (m³/h)	SURFACES UP TO (m²)	Lp dB (A) 6m	TEMP. °C min/max	WEIGHT Kg
DEPURO SKY	25091	230	460	2.08	1870	1800	330	45	-25/50	96
DEPURO SKY EVO	25092									
DEPURO SKY EASY	25093	230	460	0.77	1551	1200	265	41	-25/50	125
DEPURO SKY EASY EVO	25094									

Note: the DEPURO SKY Range products allow to set the fan speed to 100%.

Dimensions

DEPURO SKY

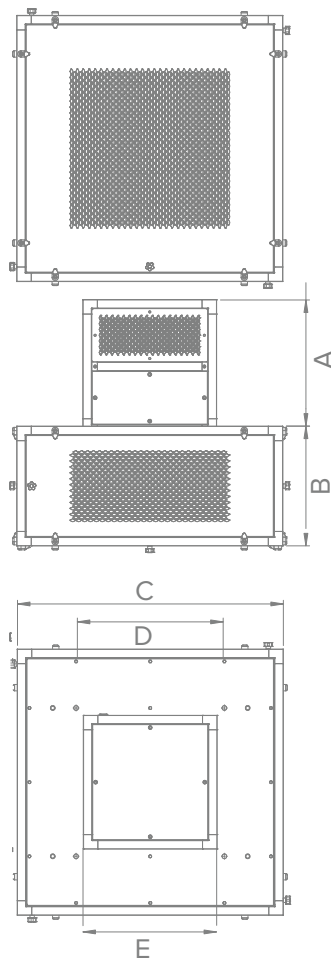

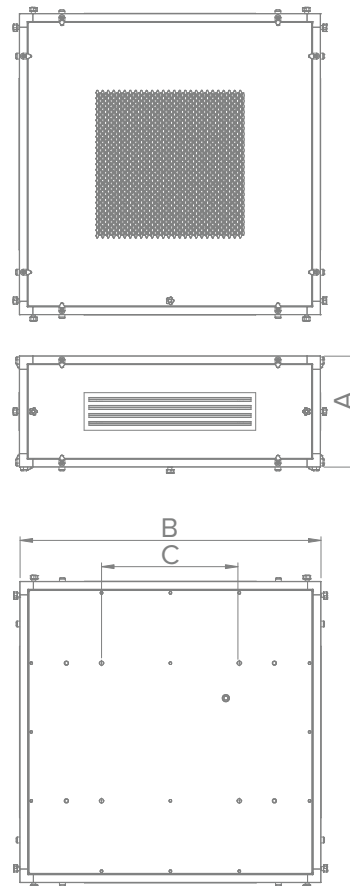

DEPURO SKY EASY



PRODUCT	A	B	C	D	E
DEPURO SKY	435	412	∅ 915	∅ 510	∅ 460
DEPURO SKY EVO					
DEPURO SKY EASY	412	∅ 1115	∅ 510	-	-
DEPURO SKY EASY EVO					

Dimensions in mm

Replacement filters

	DESCRIPTION	CODE	PRODUCT
	4FTR-ISO COARSE 65% (G4) 287x592x20 ISO COARSE 65% (G4) class filters kit (4 pieces) to be installed at each of the 4 DEPURO SKY EVO side panels. Dimensions: 287 x 592 x 20 mm	13080	25091 25092
	FTR-ISO COARSE 65% (G4) 592x592x20 ISO COARSE 65% (G4) class filter to be installed at the DEPURO SKY EVO and DEPURO SKY EASY EVO lower panel. Dimensions: 592 x 592 x 20 mm	13081	25091 25092 25093 25094
	4FTR-ISO ePM1 70% (F7) 305x610x48 ISO ePM1 70% (F7) class filters kit (4 pieces) to be installed at each of the 4 DEPURO SKY EVO side panels. Dimensions: 305 x 610 x 48 mm	13083	25091 25092
	FTR-ISO ePM1 70% (F7) 610x610x48 ISO ePM1 70% (F7) class filter to be installed at the DEPURO SKY EVO and DEPURO SKY EASY EVO lower panel. Dimensions: 610 x 610 x 48 mm	13084	25091 25092 25093 25094
	4FTR-H14 305x610x68 H14 class absolute filters kit (4 pieces) to be installed at each of the 4 DEPURO SKY EVO and DEPURO SKY EASY EVO side panels. Dimensions: 305 x 610 x 68 mm	13086	25091 25092 25093 25094
	FTR-H14 610x610x68 H14 class absolute filter to be installed at the DEPURO SKY EVO lower panel. Dimensions: 610 x 610 x 68 mm	13087	25091 25092

Filters technical data

DEPURO SKY

DESCRIPTION	EFFECTIVENESS	CODE		AVERAGE SURFACE (m ²)	PRESSURE DROP (Pa)	KG
		SIDE PANEL	FRONT PANEL			
FTR-ISO COARSE 65% (G4)	ISO COARSE 65%	13080	13081	1.03	10	3.3
FTR-ISO ePM1 70% (F7)	FTR-ISO ePM1 70%	13083	13084	19.02	10	16
FTR HEPA H14	99.995%	13086	13087	33	130	23

DEPURO SKY EASY

DESCRIPTION	EFFECTIVENESS	CODE	AVERAGE SURFACE (m ²)	PRESSURE DROP (Pa)	KG
FTR-ISO COARSE 65% (G4)	ISO COARSE 65%	13081	0.35	15	0.9
FTR-ISO ePM1 70% (F7)	FTR-ISO ePM1 70%	13084	6.5	15	6
FTR HEPA H14	99.995%	13086	22	130	16

DEPURO SKY & DEPURO SKY EVO

HIGH EFFICIENCY INSTALLATION AIR PURIFIERS AND SANITISERS
FOR CEILING AND CONCEALED INSTALLATION AND FOR COMMERCIAL AND INDUSTRIAL APPLICATIONS

EXPLODED VIEW OF THE FILTERING AND SANITISING SYSTEM*

DEPURO SKY

The photocatalysis module*, present on the EVO model only, guarantees the removal of viruses and bacteria vectors and the sanitisation of the treated air flow.

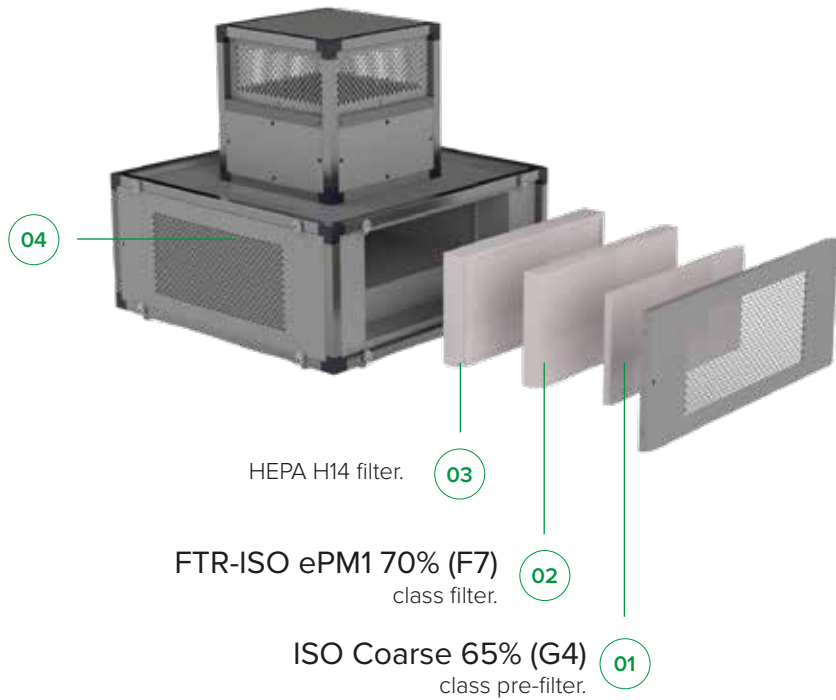

HEPA H14 filter.

FTR-ISO ePM1 70% (F7)
class filter.

ISO Coarse 65% (G4)
class pre-filter.

DEPURO SKY EASY

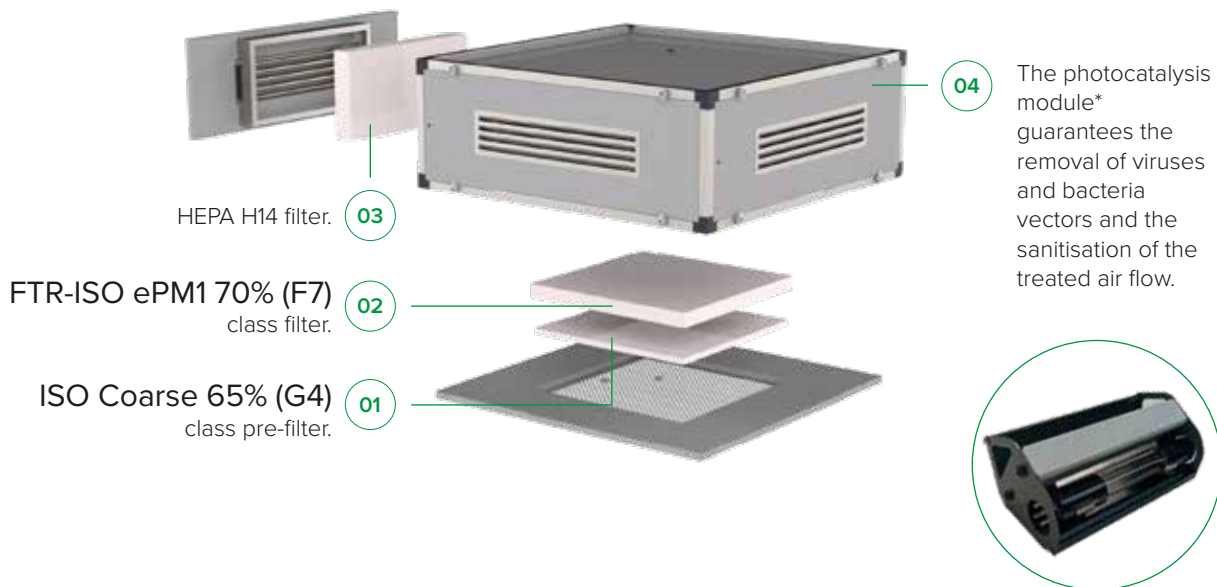

HEPA H14 filter.

FTR-ISO ePM1 70% (F7)
class filter.

ISO Coarse 65% (G4)
class pre-filter.

The photocatalysis module* guarantees the removal of viruses and bacteria vectors and the sanitisation of the treated air flow.



* The sanitisation module is installed on EVO models ONLY.

INSTALLATIONS

DEPURO SKY - FALSE CEILING INSTALLATION WITH DUCTS

In order to install the DEPURO SKY purifiers, it will be necessary to remove an accessible false ceiling plate, hang the purification unit and connect it to the ducts, which will move the purified air through a maximum of 4 interchangeable paths.

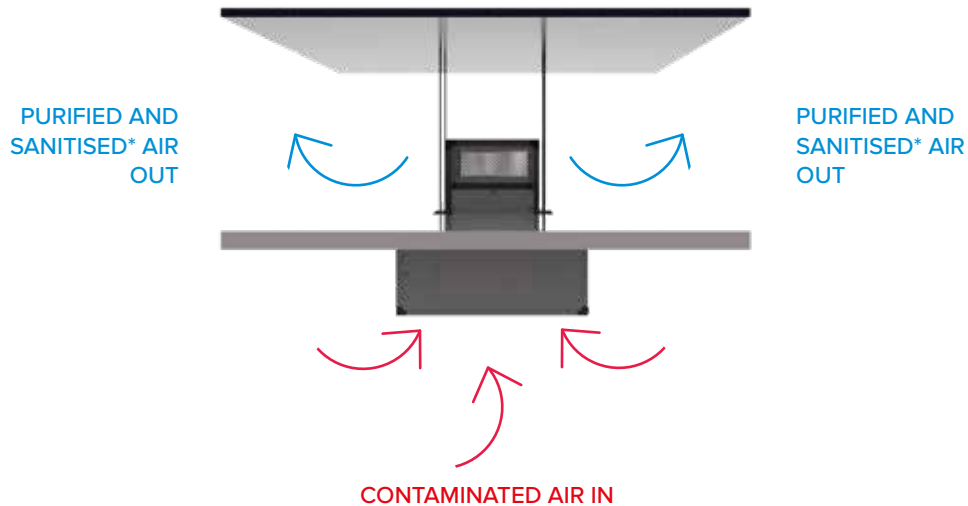

DEPURO SKY EASY - CEILING INSTALLATION

Being a decentralised system, duct installation is not necessary, as shown below. Since the DEPURO SKY EASY are compact machines, they are ideal for installations on ceilings without plates.



* The sanitisation module is installed on EVO models ONLY.

DEPURO SKY & DEPURO SKY EVO

HIGH EFFICIENCY INSTALLATION AIR PURIFIERS AND SANITISERS
FOR CEILING AND CONCEALED INSTALLATION AND FOR COMMERCIAL AND INDUSTRIAL APPLICATIONS





FAQ

Are DEPURO PLUS and DEPURO SKY purifiers effective against COVID-19?

The HEPA H14 absolute filters installed on these products are able to retain 99.995% of the particles present in the treated air with dimensions ≤ 0.3 microns, erecting an effective, albeit not absolute, barrier against the vectors through which the virus partially spreads. Therefore, the use of purifiers makes it possible to reduce the concentration of the virus present in the environment, limiting the risks of infection. According to the World Health Organization (WHO), most disease-causing pathogens are transmitted from person to person by air or by contact. Transmission by air is carried out through vectors such as droplets, of an average size greater than 5 microns, which can remain suspended in the air for a few minutes, and aerosols, between 2 and 5 microns, capable of floating for longer periods, according to their size and environmental conditions.

Another possible vector seems to be, according to some hypotheses still under investigation, the microparticulate (PM) present in the air.

The most recent studies conducted on the coronavirus SARS-COV-2, the cause of the COVID-19 pandemic, whose average size is between 0.1 and 0.16 microns, identify the main source of infection in airborne transmission*. Droplets and aerosols produced by coughs, sneezing, breathing, as well as toilet flushes and some medical procedures, once released into the environment, before decaying, retain an infectious charge for several hours, contaminating in the meanwhile surfaces and objects and thus creating the conditions for the spread of the infection through contact with eyes, nose and mouth.

Are DEPURO PLUS EVO and DEPURO SKY EVO purifiers effective against COVID-19?

The HEPA H14 absolute filters installed on these products are able to retain 99.995% of the particles present in the treated air with dimensions ≤ 0.3 microns, erecting an effective, albeit not absolute, barrier against the vectors through which the virus

partially spreads. Therefore, the use of purifiers makes it possible to reduce the concentration of the virus present in the environment, limiting the risks of infection.

The effectiveness of these EVO purifiers against pathogens, including the virus causing the COVID-19 pandemic, is further strengthened by the presence of a photocatalysis module featuring the Dust Free technology, whose effectiveness has been proved by tests performed at the Biomedical and Clinical Sciences Department "Luigi Sacco" of the University of the Studies of Milan.

What is the filtering effectiveness of the DEPURO PLUS and DEPURO SKY series purifiers?

The purifiers of these two ranges are equipped with a multiple-stage filtering section, formed by ISO coarse 65% pre-filters (G4, according to the old classification) and ISO ePM1 70% pre-filters (F7, according to the old classification), able to remove up to 65% of PM10. They retain dust and macro impurities and thus protect the underlying HEPA H14 absolute filters, able to retain 99.995% of particles ≤ 0.3 microns in size, the most dangerous for health, given their ability to reach the pulmonary alveoli, the last offshoots of our respiratory system.

Are DEPURO PLUS and DEPURO SKY purifiers equipped with high performance HEPA 14 absolute filters?

Yes, all filters belonging to these two series are subjected to strict laboratory tests that evaluate their effectiveness and ensure the achievement of the nominal abatement capacity. The HEPA H14 absolute filters of every purifier of both ranges are supplied as fully protected and sealed units and are accompanied by a specific and unique certificate, which testifies to their effectiveness.

What is the maximum volume for which the DEPURO PLUS and DEPURO SKY purifiers are effective?

The effectiveness of a purifier depends on the

*Source: Scientific and technical information on Coronavirus disease, COVID-19 (update: 4 April 2020) of the Spanish Ministry of Health, page 11, point 2.1.

volume of the environment and the concentration of pollutants in it. The smaller the environment, and therefore the volume of air to be cleaned, and the lower the pollution rate, the faster the purifying action will be.

Given the above, **the maximum volume of the target environments of the DEPURO PLUS purifiers is, respectively, 230m³ for the two 230 models, and 430m³ for the two 430 models, corresponding to surfaces of 85m² and 160m² respectively, in the case of ceilings 2.70m high.**

As for the DEPURO SKY Range models, the maximum volume is, respectively, 900m³ for the two DEPURO SKY models and 600m³ for the two DEPURO SKY EASY models, corresponding to surfaces of 330m² and 265m² respectively, in the hypothesis of ceilings 3m high.

Of course, by leaving doors open, it is possible to benefit from the action of the single product in multiple rooms.

Further information can be obtained by writing to the VORTICE Presale Service at the address: prevendita@vortice-italy.com

How can I optimise the effectiveness of DEPURO PLUS and DEPURO SKY purifiers?

The effectiveness of a purifier depends, with the same construction and quality of the mounted filters, on the treated air flow rate: the greater the volume of air passing through the filters, the less time it takes to reduce the polluting charge present in the environment.

Therefore, **the best performance of DEPURO PLUS and DEPURO SKY is obtained when their fan operates at the highest speed among those available**, compatibly with the acoustic comfort of those present (see the following point in this regard). To ensure adequate levels of environmental comfort, **it is advisable not to turn off the purifier when the air quality improves or the room is not occupied, but rather to reduce the fan speed to lower consumption and noise emissions while still**

reducing the pollutant rate.

Do DEPURO PLUS and DEPURO SKY produce ozone?

The purifiers of these two series fully comply with the regulatory safety requirements connected to the presence of ozone in the environment.

Are DEPURO PLUS and DEPURO SKY purifiers quiet?

To be effective, a purifier must:

- be equipped with filters capable of effectively retaining pollutants;
- be designed and constructed so as to avoid leakage and thus ensure that all the treated air is effectively filtered;
- fit a fan powerful enough to treat an air flow rate suitable for the size of the environment to be purified, in order to ensure its effective purification.

All this being said, it follows that a purifier, to be truly effective, cannot be completely silent. Products advertised on the basis of this feature are often not very effective, either because they are equipped with inefficient filters, or because they are equipped with poorly performing fans.

The purifiers of the DEPURO PLUS and DEPURO SKY ranges are equipped with EC fans whose speed is adjustable from 0 to 100%, so as to ensure the initial rapid reduction of the polluting charge present in the environment and the subsequent maintenance of adequate air quality levels to guarantee the health and comfort of the occupants, without causing excessive disturbance.

Do DEPURO PLUS and DEPURO SKY purifiers need maintenance?

The correct use of the purifiers of the DEPURO PLUS and DEPURO SKY ranges does not require any intervention beyond the periodic replacement of the filters and of the photocatalysis module in the EVO models.



Do you need assistance on this product?

CONTACT OUR CUSTOMER SERVICE

ITALY: prevendita@vortice-italy.com / ABROAD: export@vortice-italy.com

VORTICE GROUP COMPANIES

VORTICE S.P.A

Strada Cerca, 2
Frazione di Zoate
20067 Tribiano
(Milan) Italy
Tel. (+39) 02 906991
Fax (+39) 02 90699625
vortice.com

VORTICE LIMITED

Beeches House
Eastern Avenue
Burton on Trent
DE13 0BB United Kingdom
Tel. (+44) 1283-49.29.49
Fax (+44) 1283-54.41.21
vortice.ltd.uk

VORTICE INDUSTRIAL S.R.L.

Via B. Brugnoli 3,
37063 Isola della Scala
(Verona) Italy
Tel. (+39) 045 6631042
Fax (+39) 045 6631039
vorticeindustrial.com

CASALS VENTILACIÓN AIR INDUSTRIAL S.L.

Ctra. Camprodon, s/n 17860
Sant Joan de les Abadesses
(Girona) Spain
Tel. (+34) 972720150
casals.com

VORTICE LATAM S.A.

Bodega #6
Zona Franca Este Alajuela,
Alajuela 20101
Costa Rica
Tel. (+506) 2201 6934
vortice-latam.com

VORTICE VENTILATION SYSTEM

(Changzhou) Co.LTD
No. 388 West Huanghe Road
Building 19, Changzhou
Post Code: 213000 China
Tel. (+86) 0519 88990150
Fax (+86) 0519 88990151
vortice-china.com

TOLL-FREE NUMBER

800 555 777

The descriptions and illustrations in this catalogue are intended to be indicative and not binding. Without prejudice to the essential characteristics of the products described and illustrated here, VORTICE reserves the right to make, at any time and without notice, any changes to parts, aesthetic details or supply of accessories to its products that are deemed to be appropriate for improvement or for any construction or commercial requirement.
This printout completely cancels and replaces all previous ones.

